

## Specifications

- Current rating:1.2A AC,DC
- Voltage rating:250V AC,DC
- Temperature range:-40°C~+105°C
- Contact resistance:20mΩMax.
- Insulation resistance:1000MΩMin.
- Withstanding voltage:500V AC/minute
- \*Compliant with RoHS and REACH\*
- \*Meet the HF/Halogen Free,need to customize\*
- \*Contact CJT for details\*

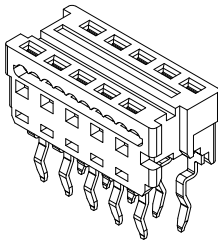
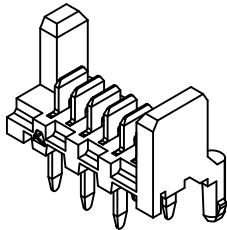
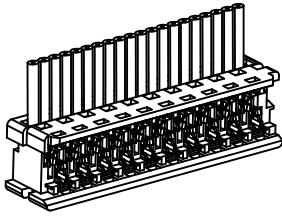

### D1272H-XP

1.27mm Flat IDC Connector

**Reference Informations:**

- \*Material:  
Terminal: Phosphor bronze/Tin over Nickel  
Housing: PBT, UL94V-0
- \*Mates with CJT D1272WV, WV-F, WV-S-F-XP series Wafer
- \*Color: White

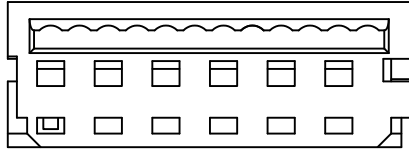
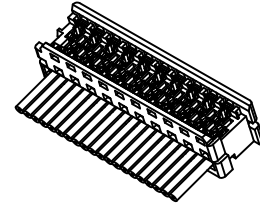

Ordering Information:  
**D1272H-XP** - \*  
 1 2  
 1. Part No.  
 2. Material:  
 (Blank): Tin over Nickel  
 G: Gold over Nickel

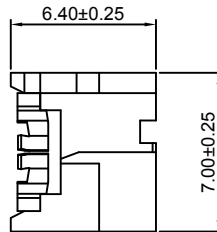
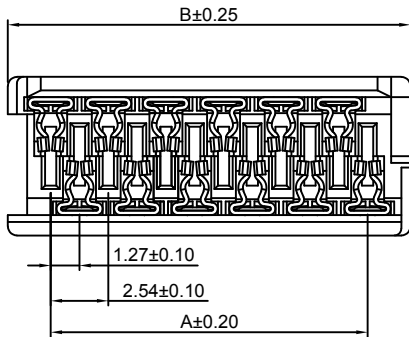

**Ordering Information & Dimensions:**

PART NO.	Dimensions	
	A	B
4P	3.81	7.59
6P	6.35	10.13
8P	8.89	12.67
10P	11.43	15.21
12P	13.97	17.75
14P	16.51	20.29
16P	19.05	22.83
18P	21.59	25.37
20P	24.13	27.91
22P	26.67	30.45
24P	29.21	32.99
26P	31.75	35.53

Unit: mm

### D1272WV-XP

1.27mm IDC 180° Wafer

**Reference Informations:**

- \*Material:  
Terminal: Phosphor bronze/Tin over Nickel  
Housing: Nylon 66, UL94V-0
- \*Mates with CJT D1272H-XP series Housing
- \*Color: Black

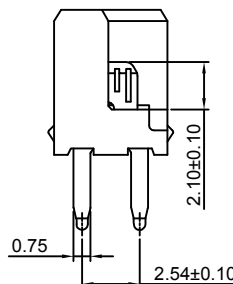
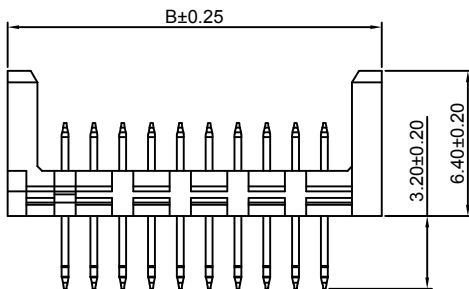
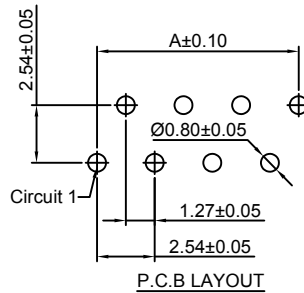
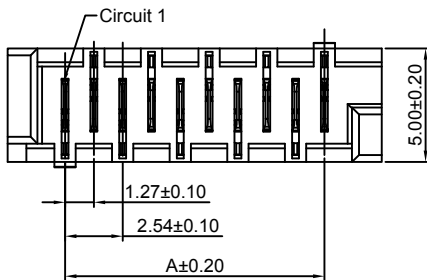
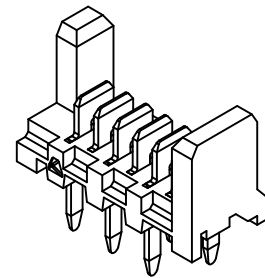

**Ordering Information & Dimensions:**

PART NO.	Dimensions	
	A	B
4P	3.81	8.86
6P	6.35	11.40
8P	8.89	13.94
10P	11.43	16.48
12P	13.97	19.02
14P	16.51	21.56
16P	19.05	24.10
18P	21.59	26.64
20P	24.13	29.18
22P	26.67	31.72
24P	29.21	34.26
26P	31.75	36.80

Unit: mm

## D1272WV-F-XP

1.27mm IDC 180° Wafer

**Reference Informations:**

- \*Material:  
Terminal: Phosphor bronze/Tin over Nickel  
Housing: Nylon 66, UL94V-0
- \*Mates with CJT D1272H-XP series Housing
- \*Color: Black

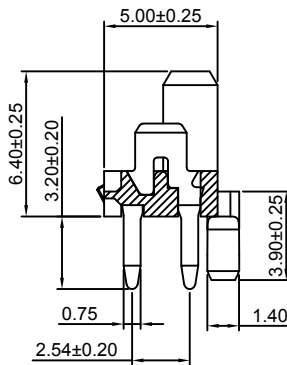
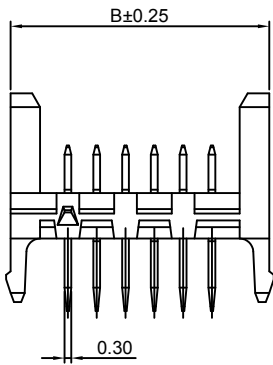
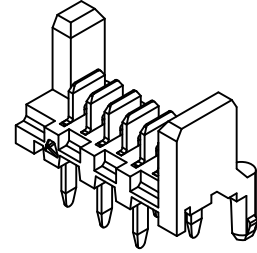
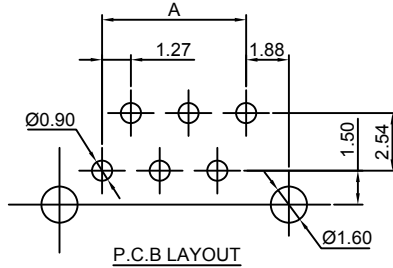
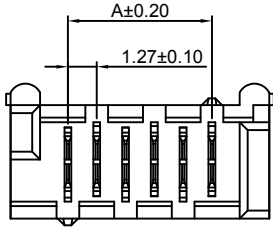

**Ordering Information & Dimensions:**

PART NO.	Dimensions	
	A	B
4P	3.81	8.86
6P	6.35	11.40
8P	8.89	13.94
10P	11.43	16.48
12P	13.97	19.02
14P	16.51	21.56
16P	19.05	24.10
18P	21.59	26.64
20P	24.13	29.18
22P	26.67	31.72
24P	29.21	34.26
26P	31.75	36.80

Unit: mm

## D1272WV-S-F-XP

1.27mm IDC 180° Wafer - SMT TYPE

**Reference Informations:**

- \*Material:  
Terminal: Phosphor bronze/Tin over Nickel  
Housing: LCP, UL94V-0
- \*Mates with CJT D1272H-XP series Housing
- \*Color: Black

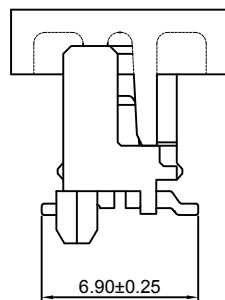
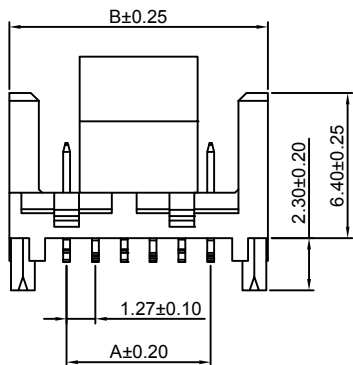
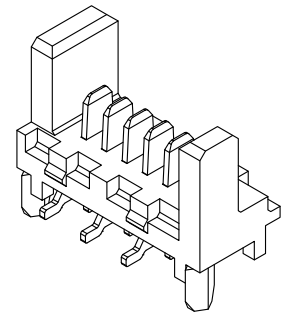
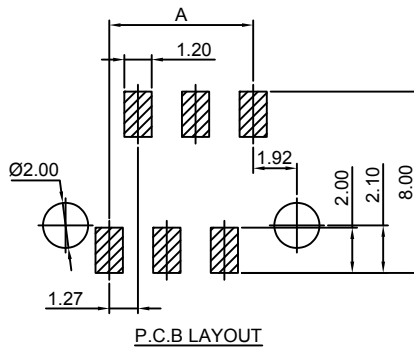
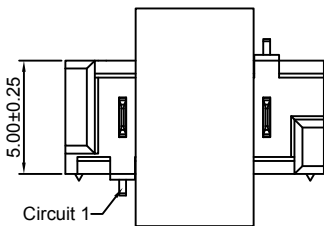

**Ordering Information & Dimensions:**

PART NO.	Dimensions	
	A	B
4P	3.81	8.86
6P	6.35	11.40
8P	8.89	13.94
10P	11.43	16.48
12P	13.97	19.02
14P	16.51	21.56
16P	19.05	24.10
18P	21.59	26.64
20P	24.13	29.18
22P	26.67	31.72
24P	29.21	34.26
26P	31.75	36.80

Unit: mm

### D1272HV-XP

1.27mm Flat IDC Connector

**Reference Informations:**

\*Material:

Terminal: Phosphor bronze/Tin over Nickel

Housing: PBT, UL94V-0

\*Color: White

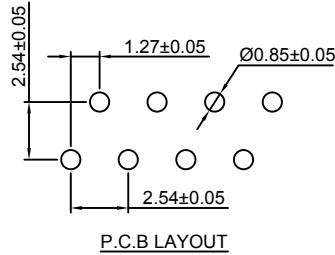
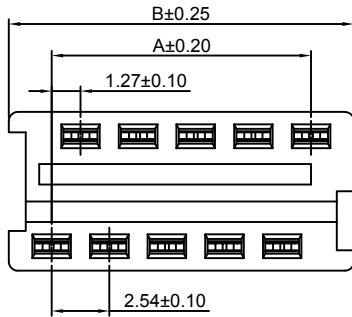
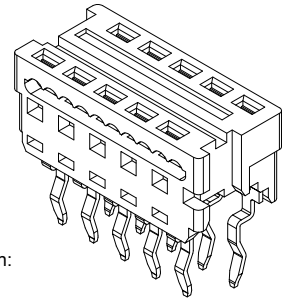

**Ordering Information:**

D1272HV-XP - \*  
1 2

1.Part No.

2.Material:

(Blank): Tin over Nickel

G: Gold over Nickel

**Ordering Information & Dimensions:**

PART NO.	Dimensions	
	A	B
4P	3.81	8.86
6P	6.35	11.40
8P	8.89	13.94
10P	11.43	16.48
12P	13.97	19.02
14P	16.51	21.56
16P	19.05	24.10
18P	21.59	26.64
20P	24.13	29.18
22P	26.67	31.72
24P	29.21	34.26
26P	31.75	36.80

Unit: mm

